

Ethernet-SPI/DMX Pixel light controller User Manual



(Please read through this manual carefully before use)

Update Time: 2019.11.25

1. Brief Introduction

This Ethernet-SPI/DMX pixel light controller is dedicated to converting the Ethernet signal into SPI pixel signal, which is designed for large project with high-density pixel light...

2. Specifications

Table with 3 columns: Model, Working Voltage, Output Current, Input Ethernet control protocol, Output Control IC, Control Pixels, Output DMX512, Working Temp, Product Dimension, Weigh(G.W).

1

3. Basic Features

- 1. With LCD display and built-in WEB SERVER setting interface, easy operation.
2. Support Ethernet DMX protocol ArtNet, sACN(E1.31)(only V2 versions), can be expanded to other protocols.
3. Multi SPI (TTL) signal output.
4. Output DMX512 signal at the same time, convenient for the connection of different types led lamp.
5. Support various LED driving IC,flexible control.
6. Support online firmware upgrade.
7. Adopt DIP plug-in design for the easily-worn parts, Users can repair the damage caused by wrong wiring or short circuit.
8. Built-in test mode, using a network interface with indicator light, work status is clear when at a glance.

4. Safety warnings

- 1. Please don't install this controller in lightning, intense magnetic and high-voltage fields.
2. To reduce the risk of component damage and fire caused by short circuit, make sure correct connection.
3. Always be sure to mount this unit in an area that will allow proper ventilation to ensure a fitting temperature.
4. Check if the voltage and power adapter suit the controller.
5. Don't connect cables with power on, make sure a correct connection and no short circuit checked with instrument before power on.
6. Please don't open controller cover and operate if problems occur.
The manual is only suitable for this model; any update is subject to change without prior notice.

5. Dimensions

Unit: mm

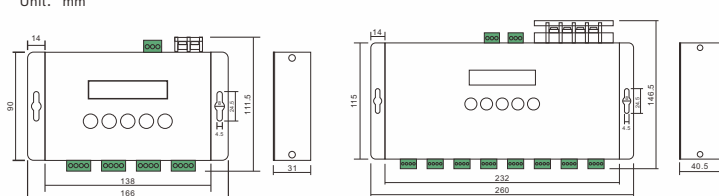

6. Operating Instructions

204 216 Instruction of interface and ports:

2

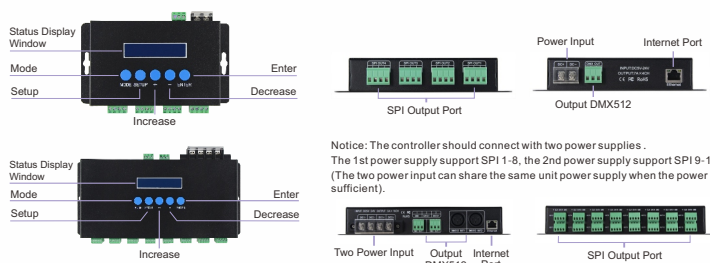

Wiring instructions of SPI output port :

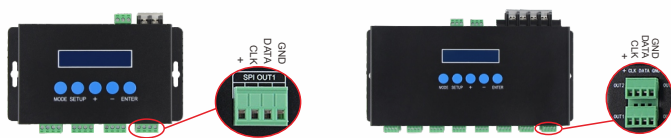

To output LPD6803/LPD8806/P9813/WS2801 controlling signal , it required at least three lines :

Table with 2 columns: Signal Name (DATA, CLK, GND) and Description (6803/8806/9813/2801 DATA, etc).

To output WS2811/ TLS3001/TM1814/SK6812 controlling signal, it required at least two lines :

Table with 2 columns: Signal Name (DATA, GND) and Description (WS2811/ TLS3001 DATA, etc).

Connect the Lamps positive supply to the + of the SPI output ports.

1. Key Description

Table with 3 columns: Button, Short Press Function, Long Press Function.

2. Operating and setting instructions

Ethernet-SPI/DMX pixel light controller with two working models. Respectively : normal working mode and test mode.

3

(1) Normal working mode

Normal mode is based on Ethernet transferring ArtNet protocol into a control signal which can be received by various pixel lamps; Connecting the lamps, plugging the network cable, after checking, power on. The controller will enter into the network detection.

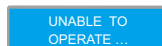

After detecting without problems, the controller will enter into normal working mode and show the IP address, IP address has static and dynamic allocation. STAT for static allocation, DHCP for dynamic allocation, the controller default IP address is static.



This controller also comes with key lock function, no operation after 30 seconds, the system enters the lock state, then LCD shows.



Long press "MODE" to unlock, unlocked before next operation.

(2) Parameter Setting

In normal working mode, press "MODE" to switch parameter setting type, "SETUP" to enter the setup, then press "ENTER" to get back to previous level.

Table with 4 columns: NO., Setting, LCD display, Value. Lists various system and channel settings.

4

Table with 4 columns: Setting, LCD display, Value. Lists DMX channel, pixel, and output settings.

Control ICs type:

Table with 3 columns: IC Type, Compatible ICs, Type. Lists various IC models like TM1803, WS2811, etc.

5

(3) Test mode

Long press "MODE" to enter the test mode, press it again to exit, after entering the test mode, press "+" "-" to switch the mode and "SETUP" to set the parameter of the current mode. After enter into test mode, the LCD will show operation tips, as below:



Table with 4 columns: NO., Built-in sequences, NO., Built-in sequences. Lists various test patterns like Solid color, Rainbow chase, etc.

3. WEB setting, Firmware upgrading online.

In addition to set parameters by buttons, you can also set it through the Web browser of computer. The parameter settings between the two are the same.

WEB operation instructions:

Open the web browser of the computer, which is in the same LAN with the controller, input the IP address (such as the default IP: 192.168.0.50), and press "Enter" to browse the controller's built-in website, as shown below:

User Login

User login form with fields for Controller Name, Password, and a Login button.

6

Enter the default password : 12345 , Click Login to enter the parameter setting page. The users can set the parameter and upgrade the firmware on website.

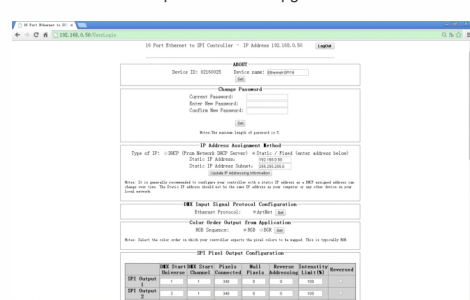

Upgrade the firmware online:

To find the column "Firmware Update" on website (as below)



Then click After downloading updated firmware to Computer - Click to Update Firmware, to enter the firmware update page(as below), click Choose file, then choose the BIN file you need to upgrade, then click Update enter into firmware updating page, After upgrade, the website will auto matically back to the login screen.

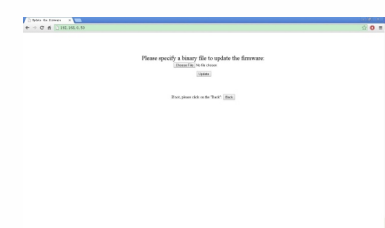

7

7. Conjunction Diagram

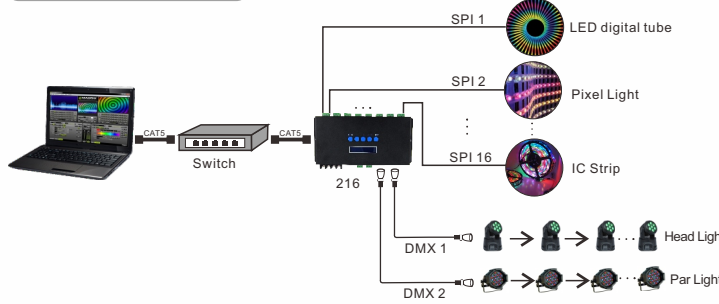

8. After-Sales

From the day you purchase our products within 3 years, if being used properly in accordance with the instruction, and quality problems occur, we provide free repair or replacement services except the following cases:

- 1. Any defects caused by wrong operations.
2. Any damages caused by inappropriate power supply or abnormal voltage.
3. Any damages caused by unauthorized removal, maintenance, modifying circuit, incorrect connections and replacing chips.
4. Any damages due to transportation, breaking, flooded water after the purchase.
5. Any damages caused by earthquake, fire, flood, lightning strike etc force majeure of natural disasters.
6. Any damages caused by negligence, inappropriate storing at high temperature and humidity environment or near harmful chemical.

8